

KA113

Amplifier,
Low Noise
0.02 – 8.0 GHz

DESCRIPTION

The KA113 is a GaAs pHEMT broadband Low Noise Amplifier with high linearity in a hermetic Surface-Mount Technology (SMT) package for high reliability applications. This Amplifier offers excellent gain, Low noise and high linearity from 20 MHz to 8.0 GHz. Independent enable bias pin can be used to optimize device performance for linearity or noise figure. It can be supplied and tested to the screening requirements of MIL-PRF-38535 Class B and S in addition to the required QCI.

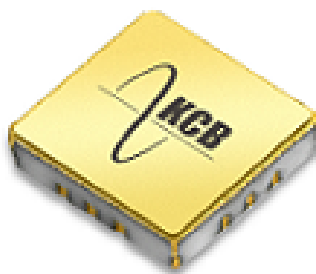

FEATURES

- ✓ High Gain: 18 dB typical @ 2 GHz.
- ✓ Low Noise Figure: 1.4 dB typical @ 2 GHz.
- ✓ High OIP3dB: +35 dBm typical @ 2 GHz.
- ✓ Independent enable bias for performance optimization
- ✓ NASA EEE-INST-002 compliant.
- ✓ High Reliability Class B and S Screening Available.
- ✓ See Page 5 for MFR HI –REL Ordering Details.

APPLICATIONS

- ✓ PA Driver
- ✓ Cascaded Gain Block
- ✓ GPS Transceivers
- ✓ IF Amplifier

ELECTRICAL CHARACTERISTICS (-40 to +85 C, $V_{DD} = +5VDC$)^{1, 2}

Parameter	Symbol	Conditions	Min	Typical	Max	Units
Gain	S21	0.02 – 2.0 GHz	17	18		dB
		2.0 – 4.0 GHz	14	16		
		4.0 – 8.0 GHz		12		
Input Return Loss	S11	0.02 – 2.0 GHz	8	10		dB
		2.0 – 4.0 GHz	12	14		
		4.0 – 8.0 GHz	7	9		
Output Return Loss	S22	0.02 – 2.0 GHz	7	9		dB
		2.0 – 4.0 GHz	4	6		
		4.0 – 8.0 GHz	2	4		
Supply Current	I_{DD}	$V_{DD} = 5V$		66	90	mA

1. All electrical characteristics are measured at +25 C at a minimum.
2. V_{ENABLE} adjusted to achieve typical current.

KA113 | Amplifier, Low Noise 0.02 – 8.0 GHz

OPERATING CHARACTERISTICS (-40 to +85 °C, $V_{DD} = +5$ VDC)^{1, 2}

Parameter	Symbol	Conditions	Min	Typical	Max	Units
Output Compression Point	OP1dB	0.02 – 2.0 GHz		+21		dBm
		2.0 – 4.0 GHz		+19		dBm
		4.0 – 8.0 GHz		+18		dBm
3rd order output intercept point (+/- 1% spacing)	OIP3	0.02 – 2.0 GHz		+35		dBm
		2.0 – 4.0 GHz		+33		dBm
		4.0 – 8.0 GHz		+31		dBm
Noise Figure	NF	0.02 – 2.0 GHz		1.3	1.7	dB
		2.0 – 4.0 GHz		1.5	2.0	dB
		4.0 – 8.0 GHz		2.2	3.2	dB

1. All operating characteristics are guaranteed over full performance temperature range but not tested.
2. V_{ENABLE} adjusted to achieve typical current.

TYPICAL PERFORMANCE (+25 °C)

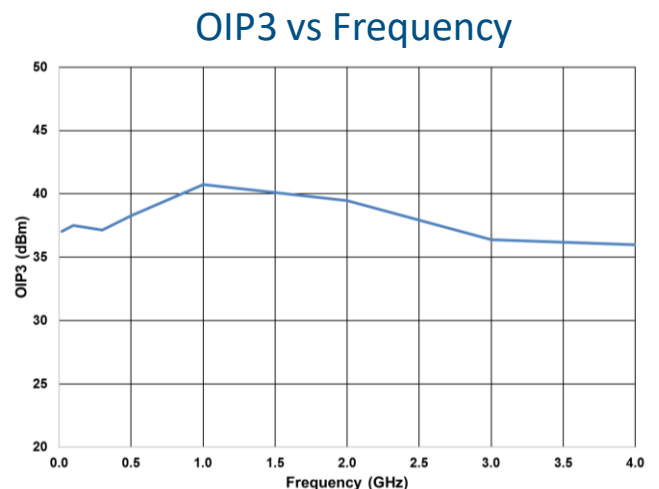
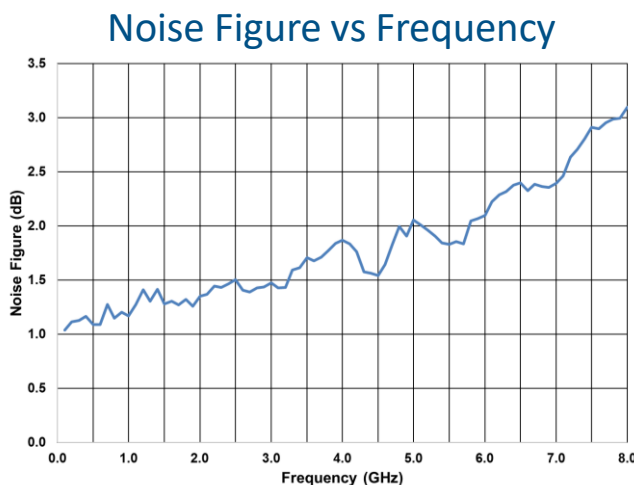
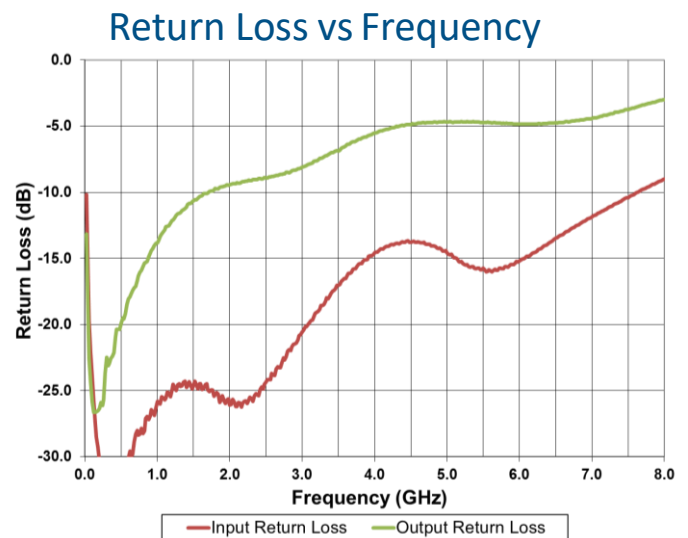
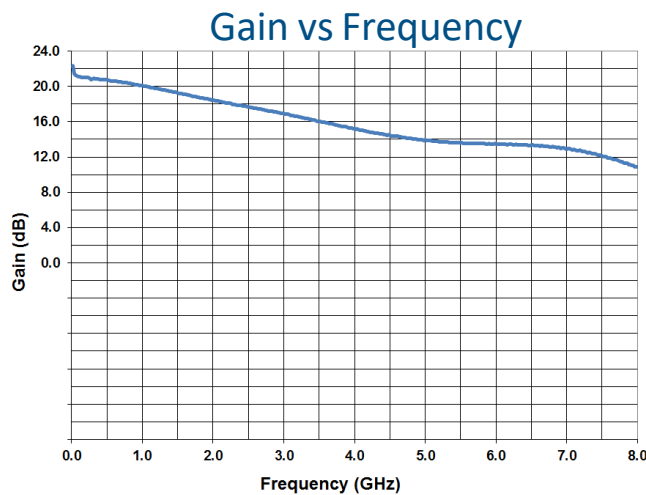

KA113 | Amplifier, Low Noise 0.02 – 8.0 GHz

ABSOLUTE MAXIMUM RATINGS

Characteristic	Symbol	Min.	Typ.	Max.	Units
Supply voltage	V_{DD}			6.0	V
Enable voltage	V_{ENABLE}			8.0	V
RF Input power	P_{IN}			+20	dBm
Operating temperature	T_{OP}	-40		+85	°C
Storage temperature	T_{STG}	-65		+150	°C
Channel temperature (MTTF > 170 Hrs)	T_{CH}			+170	°C
Dissipated Power	P_{DISS}			1.5	W
Thermal resistance	θ_{JC}		103		°C/W
ESD sensitivity (HBM)		250 (Class 1A)			V



Caution: Class 1A (HBM 250V) Electrostatic Sensitive Device. Proper ESD precaution should be used when handling device.

- Unit shall survive operation without damage over the temperature range but not tested.

DEVICE MARKING/PIN OUT:

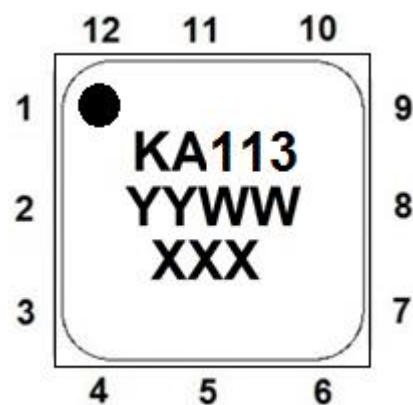

PIN	Designation	PIN	Designation
1	GND	7	GND
2	RF IN	8	RF OUT/ V_{DD}
3	GND	9	GND
4	GND	10	GND
5	GND	11	GND
6	GND	12	V_{ENABLE}

PACKAGE/MARKING NOTES:

- Lid: ASTM F-15 Alloy
- Base/Walls: Alumina
- Lid/Bottom Finish: Gold over Nickel
- KA113: Part Number
- YYWW: Lot Date Code
- XXX: Serial number (added for class B and S devices only)

ADDITIONAL NOTES:

- Maximum reflow temperature: 265°C
- Package base is RF ground
- External blocking capacitors required on all RF ports



KA113 | Amplifier, Low Noise 0.02 – 8.0 GHz

OUTLINE:

Dimensions are shown in inches.

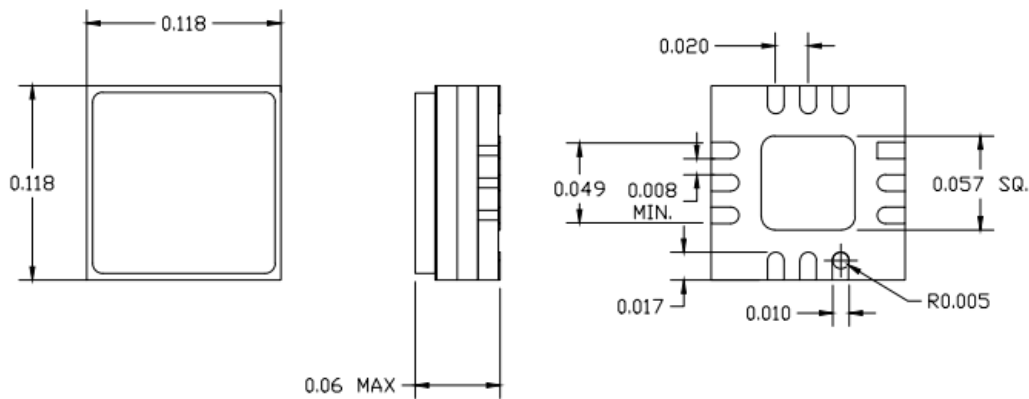

RECOMMENDED SOLDER LAYOUT:

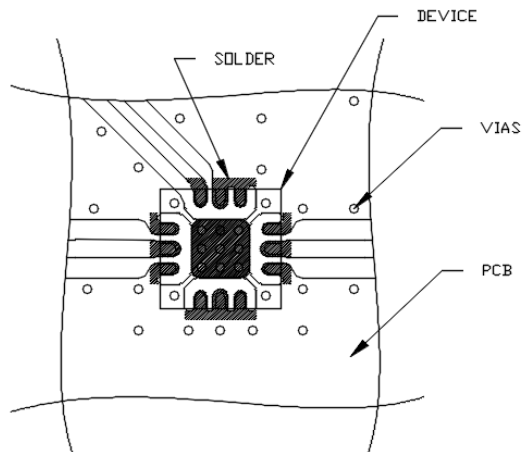

NOTES:

1. TRANSMISSION LINES SCALED FOR ROGERS R04003, 0.008 INCHES THICK
2. GROUND ALL UNUSED PORTS
3. MAXIMUM REFLOW TEMPERATURE: 265C.
4. DXF FILE AVAILABLE UPON REQUEST.
5. CONTACT KCB SOLUTIONS FOR FURTHER GUIDANCE ON DEVICE PLACEMENT AND ATTACHMENT

KA113 | Amplifier, Low Noise 0.02 – 8.0 GHz

EVALUATION BOARD AND SCHEMATIC

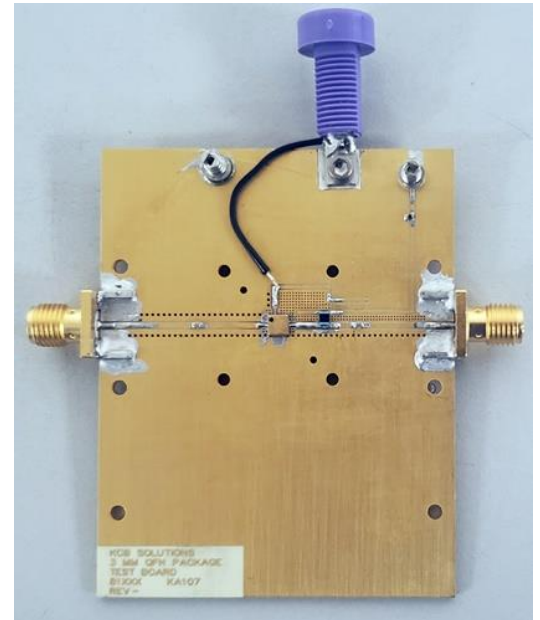
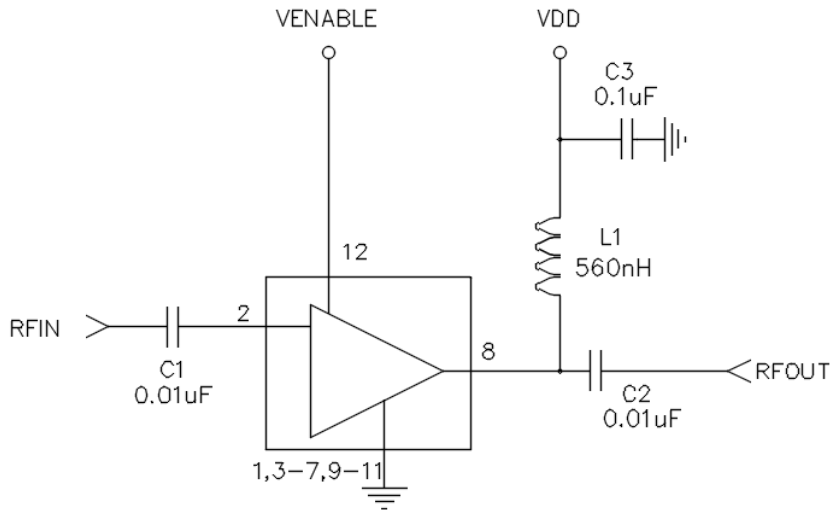

Reference Designator	Part Number	Description	Manufacturer
C1, C2	GCM155R71H103KA55D	Capacitor, Ceramic 0.01uF 0402	Murata
C3	GRM155R61H104KE19D	Capacitor, Ceramic 0.1uF 0402	Murata
L1	0603LS-561XGRC	Inductor, Ferrite Core, 560nH	Coilcraft

Note: V_{ENABLE} can be adjusted to optimize bias current for either higher linearity or lower noise figure.

KA113 | Amplifier, Low Noise 0.02 – 8.0 GHz

TAPE & REEL:

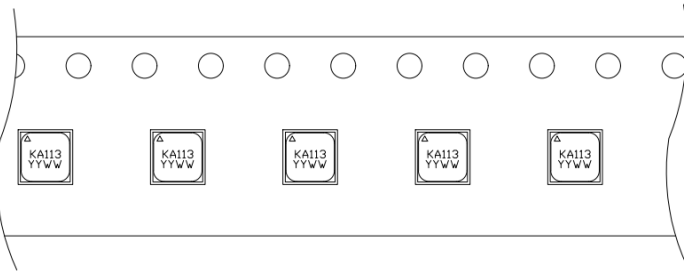

- W = 12MM
- P0 = 4MM
- P1 = 8MM
- P2 = 2MM

SCREENING FLOW (MIL-PRF-38535):

Test Inspection	MIL – STD -883		Requirement	
	Method	Condition	Class B	Class S
Wafer Lot Acceptance /1	5007		N/A	Per Wafer Lot
Non-Destructive Bond Pull	2023		SPC	SPC
Internal Visual	2010	A= Class S, B = Class B	100%	100%
Temperature Cycle	1010	C	100%	100%
Acceleration	2001	E (Y1 only)	100%	100%
PIND	2020	A (5 Cycles)	N/A	100%
Serialization	Per Product Specification		100%	100%
Radiographic	2012	2 views	N/A	100%
Electrical Test	Small Signal Testing	+25°C	100%	100%
Burn In	1015	A	100%/160 Hours/ 125 °C	100%/320 Hours/ 125 °C
Final Electrical	Small Signal Testing	+25°C	100%	100%
PDA Calculation	5004	1dB Δ Gain / 20% Δ I _{DD}	5%	5%/3% functional
Group A Electrical /5	Per Product Specification		45/0	45/0
Leak Test	1014 A and C	1 x 10 ⁻⁸ Max	100%	100%
External Visual	2009		100%	100%

Notes:

1. Product under configuration control per KCB QAP 015.
2. Customer will be notified of all class 1 changes for Class B and S part numbers.
3. Wafer Lot Acceptance will include 100% die visual, SEM analysis and Lot Traceability.
4. Electrical Test Data will be recorded for each serial number and included in Final Test Report for all Class S part numbers.
5. Group A Electrical testing will include the Small Signal at the Min/Max operating condition. The Dynamic test (P1dB, IP3, NF) will be tested at +25c only.

ORDERING INFORMATION:

	Unscreened	Class B	Class S
KCB Solutions Part Number	KA113C	KA113B	KA113S

