

# KA115

Amplifier,  
Low Noise  
2-18 GHz

## DESCRIPTION

The KA115 is a GaAs pHEMT broadband Low Noise Amplifier with high linearity in a hermetic surface mount package. This Amplifier offers excellent gain, Low noise and high linearity from 2 GHz to 15 GHz. It can be supplied and tested to the screening requirements of MIL-PRF-38534 Class H and K in addition to the required QCI.

## FEATURES

- ✓ High Gain: 17 dB typical.
- ✓ Low Noise Figure: 2 dB typical @ 2-15 GHz.
- ✓ High OIP3: +29 dBm typical @ 2-15 GHz.
- ✓ NASA EEE-INST-002 compliant.
- ✓ High Reliability Class H and K Screening Available.
- ✓ See Page 6 for MFR HI –REL Ordering Details.

## APPLICATIONS

- ✓ PA Driver
- ✓ Cascaded Gain Block
- ✓ IF Amplifier



TABLE1: ELECTRICAL CHARACTERISTICS (0 to +75 C)<sup>1</sup>

Parameter	Symbol	Conditions	Min	Typical	Max	Units
Gain	S <sub>21</sub>	2-15 GHz		17		dB
Gain Variation Over Temperature					1.0	dB
Gain Flatness					2	dB
Input VSWR		2–15 GHz		15		dB
Output VSWR		2–15 GHz		15		dB
Supply Current	I <sub>DD</sub>	VDD = 5V		75		mA
Gate Voltage	V <sub>g1</sub>			-0.6		V
Gave Voltage	V <sub>g2</sub>			1.4		V

1. All electrical characteristics are measured at +25 C at a minimum.

# KA115 | Amplifier, Low Noise 2 – 15 GHz

**TABLE 2: OPERATING CHARACTERISTICS (0 TO +75 °C)**

Parameter	Symbol	Conditions	Min	Typical	Max	Units
Output 3 <sup>rd</sup> Order Intercept Point	OIP3	2 – 14 GHz		+29		dBm
	OIP3	14 – 15 GHz		+25		dBm
Output Compression Point	OP1dB	2 – 14 GHz		+14		dBm
		14 – 15GHz		+13		dBm
Saturated Output Power	OP2dB	2 – 14 GHz		+18		dBm
		14 – 15 GHz		+17		dBm
Noise Figure	NF	2 – 14 GHz		2		dB
		14 – 15 GHz		4		dB

**TABLE 3: STABILITY CHARACTERISTICS (0 TO +75 °C)**

Parameter	Symbol	Conditions	Min	Typical	Max	Units
K-Factor Stability <sup>1</sup>	K	10 – 3000 MHz	1.2			
B1-Factor Stability <sup>1</sup>	B1	10 – 3000 MHz	0		1	

Notes:

1. Guaranteed by design but not tested.

## ABSOLUTE MAXIMUM RATINGS<sup>1</sup>

Characteristic	Symbols	Min.	Typ.	Max.	Units
Drain to Gate Voltage	Vd-Vg			10	V
Drain Voltage	Vd			7	V
Gate 1 Voltage Range	Vg1			-2 to 0	V
Gate 2 Voltage Range	Vg2			-2 to +3	V
Drain Current	Id			144	mA
RF Input power	Pin			+22	dBm
Operating temperature (No damage) <sup>2</sup>		-40		+105	°C
Storage temperature		-65		+150	°C
Channel temperature	MTTF > 9.7E+08 Hrs			+96	°C
Dissipated Power				1.01	W
Thermal resistance				44.2	°C/W
ESD sensitivity	HBM	250 (Class 1A)			V

### Notes

1. Stresses above those listed under “Absolute Maximum Rating” may cause permanent damage to this device. This is a stress rating only and functional operation of the device. At these or any other conditions above those indicated in the operational sections of this specification is not implied. Exposure to absolute maximum rating conditions for extended periods may affect device reliability.
2. Device shall function but may not meet performance specifications.

# KA115 | Amplifier, Low Noise 2 – 18 GHz

TYPICAL PERFORMANCE (+25 °C)

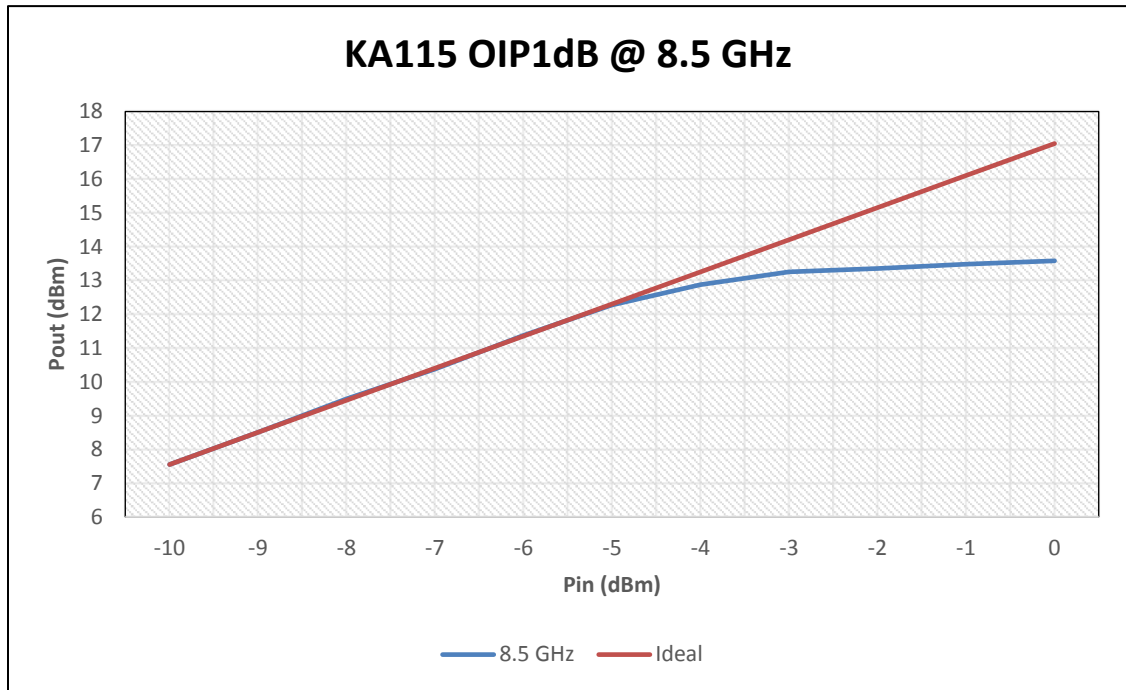
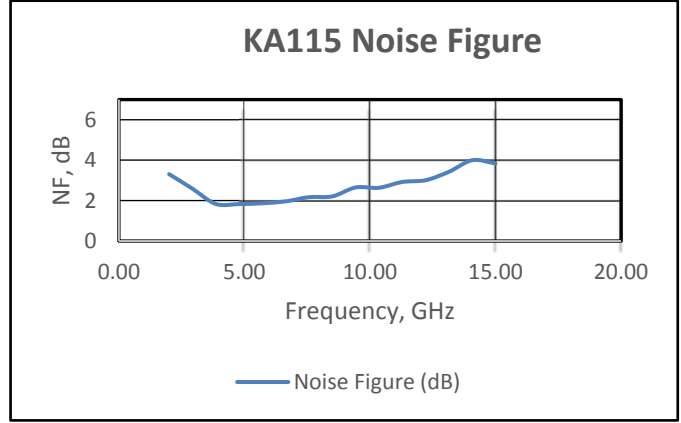
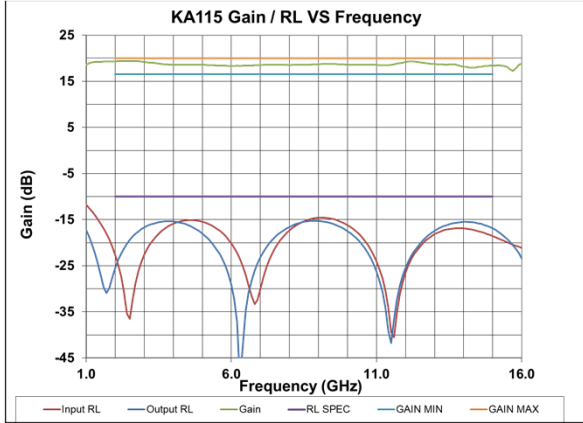

## PERFORMANCE OVER TEMPERATURE

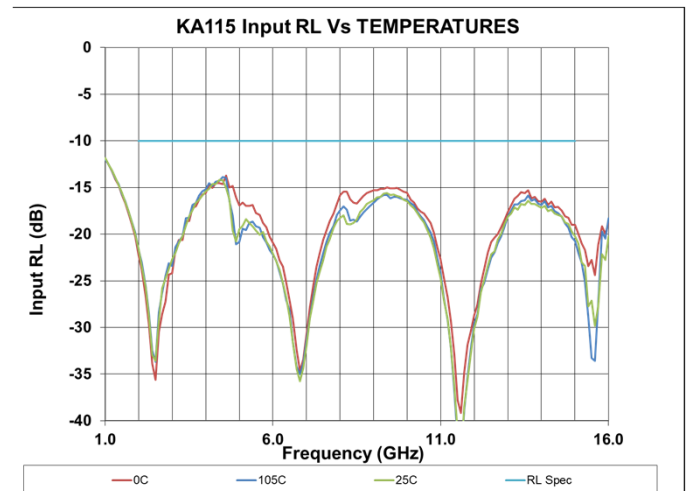
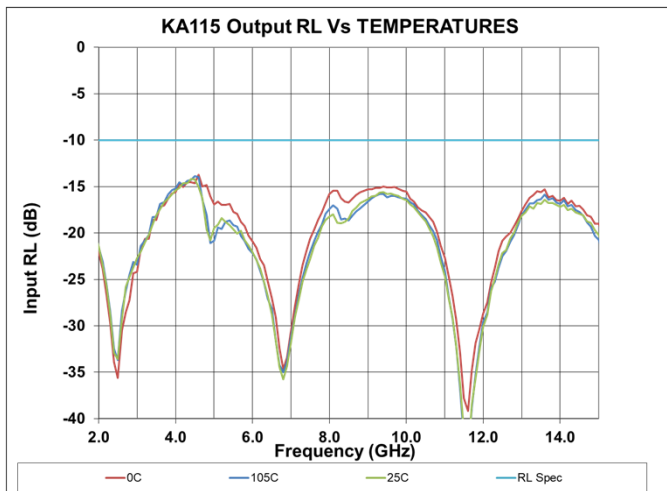
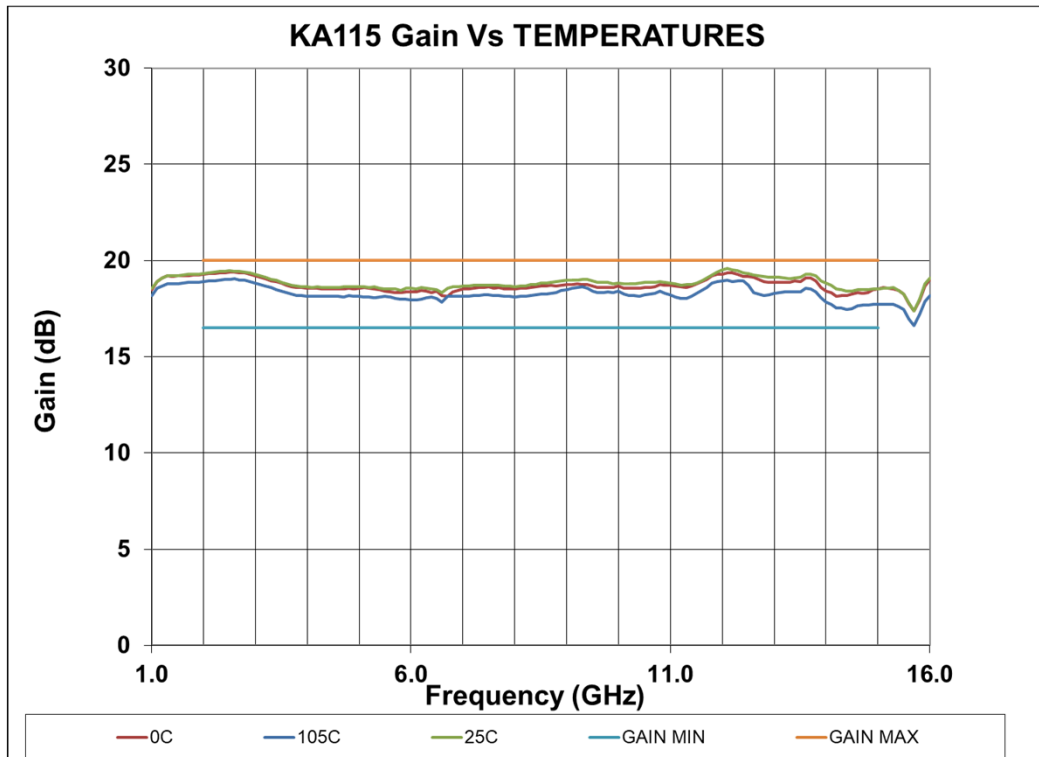

# KA115 | Amplifier, Low Noise 2 – 15 GHz

## DEVICE MARKING/PIN OUT:

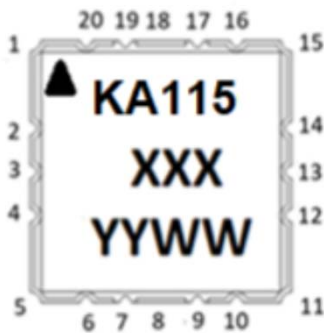

Pin #	Description	Pin #	Description
1	GND	11	GND
2	N/C	12	N/C
3	Vd	13	N/C
4	Vg2	14	Vg1
5	GND	15	GND
6	N/C	16	N/C
7	GND	17	GND
8	RF In	18	RF Out
9	GND	19	GND
10	N/C	20	N/C

## PACKAGE/MARKING NOTES:

- KA115: Part Number (See ordering information on page 8)
- XXX: Serial number (added for class H and K devices only)
- YYWW: Lot Date Code



Caution: Class 1A (HBM)  
Electrostatic Sensitive Device.  
Proper ESD precaution should  
be used when handling device.

## TAPE AND REEL INFORMATION:

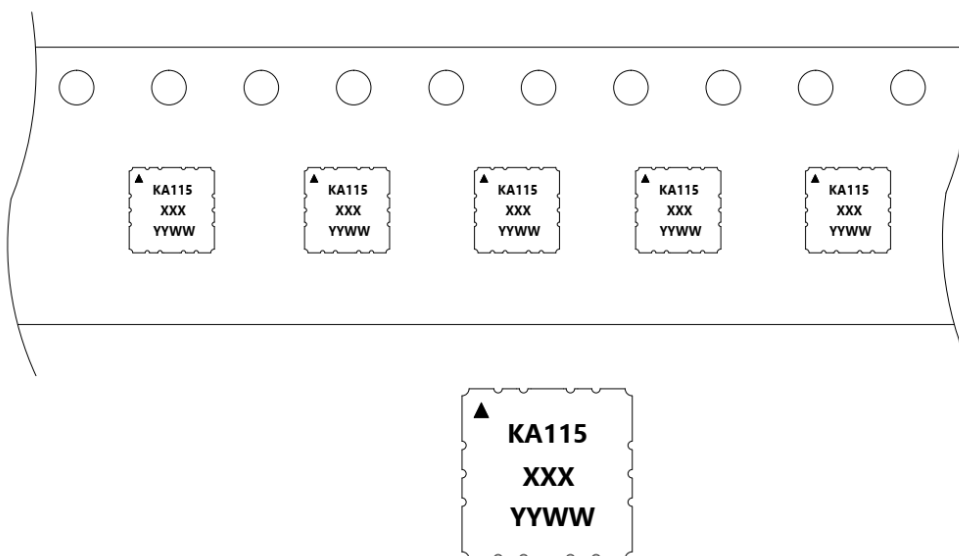

KCB Tape and Reel P/N: US042041

- A0 (Width) = 6.60 mm
- B0 (Length) = 6.60 mm
- K0 (Thickness) = 1.55 mm

## ADDITIONAL NOTES:

- Maximum reflow temperature: 320°C for 90 seconds maximum
- Package base is RF and DC ground



# KA115 | Amplifier, Low Noise 2 – 15 GHz

## OUTLINE:

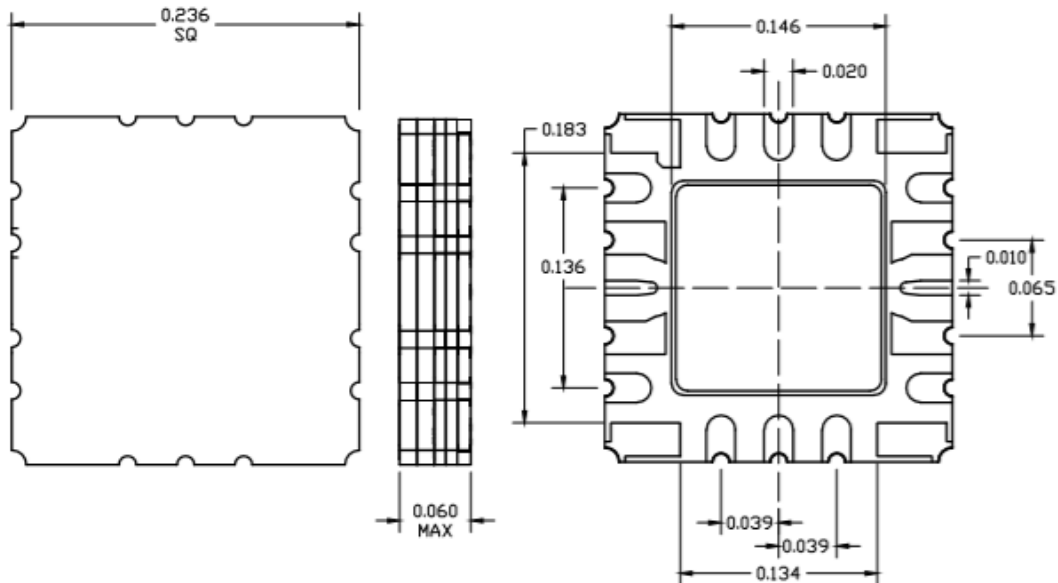

## RECOMMENDED SOLDER LAYOUT:

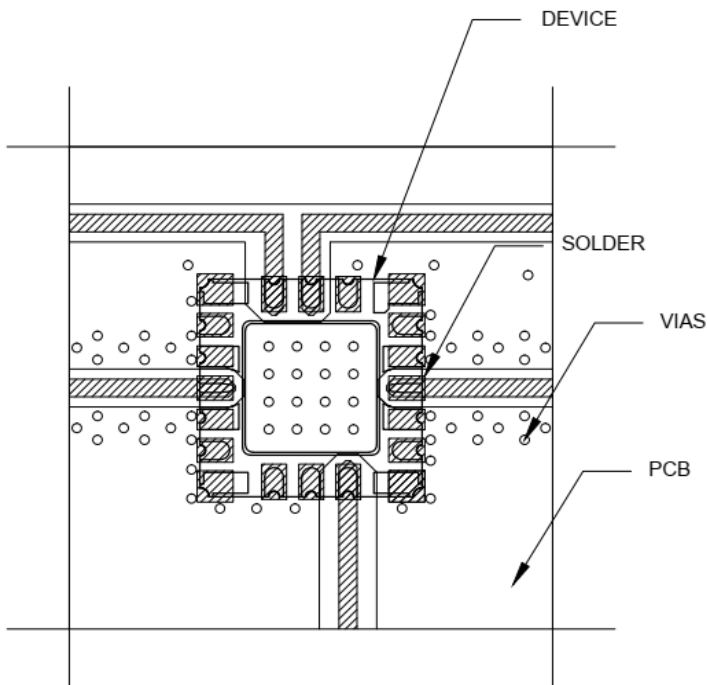

### NOTES:

1. TRANSMISSION LINES SCALED FOR ROGERS RO4350, 0.008 INCHES THICK
2. GROUND ALL UNUSED PORTS
3. MAXIMUM REFLOW TEMPERATURE: 265C.
4. DXF FILE AVAILABLE UPON REQUEST.
5. CONTACT KCB SOLUTIONS FOR FURTHER GUIDANCE ON DEVICE PLACEMENT AND ATTACHMENT

# KA115 | Amplifier, Low Noise 2 – 15 GHz

## EVALUATION BOARD SCHEMATIC:

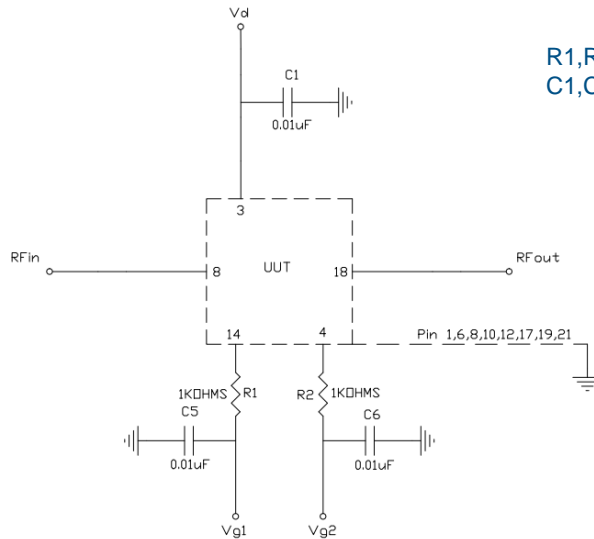

R1,R2: 1Kohm 0603. Part #:ERJ-3GEYJ102V)  
C1,C5,C6: 0.01 uF. Part #: GRM216R71H103KAO1D

Note: Pin 2,5,6,7,9,10,11,12,13,15,16,17,19,20 are NC or GROUNDED  
Vd,Vg1,Vg2 connect to D-Sub connector

## SCREENING FLOW (MIL-PRF-38534):

Test Inspection	MIL – STD -883		Requirement	
	Method	Condition	Class H	Class K
Element Evaluation	MIL-PRF-38534	Table C-1	Per Table	Per Table
Non-Destructive Bond Pull	2023		Process under SPC	100%
Internal Visual	2010	A = Class H, B = Class K	100%	100%
Temperature Cycle	1010	C, 10 Cycles	100%	100%
Acceleration	2001	B (Y1 only)	100%	100%
PIND	2020	A (5 Cycles)	N/A	100%
Serialization	Per Product Specification		100%	100%
Radiographic	2012		N/A	100%
Electrical Test	Per Product Specification	+25°C	100%	100%
Burn In	1015	A	100%/160 Hrs/125°C	100%/320 Hrs/125°C
Final Electrical	Per Product Specification	+25°C	100%	100%
Group A Electrical	Per Product Specification	0°C/+ 75°C	45/0	45/0
Seal: Fine Leak		A		
Gross Leak	1014	C	100%	100%
External Visual	2009		100%	100%

### Notes:

1. Product under configuration control per KCB QAP 015.
2. Customer will be notified of all class 1 changes for Class H and K part numbers.
4. Electrical Test Data will be recorded for each serial number and included in Final Test Report for all Class K part numbers.
5. Group A Electrical testing will include parameters in Table 1. The Dynamic test (Table 2) will be tested at +25c only.

## ORDERING INFORMATION:

	Unscreened	Class H	Class K
KCB Solutions Part Number	KA115C	KA115H	KA115K

