

KS109-55

SP4T 100W Switch
0.225 – 2.5 GHz

DESCRIPTION

The KS109-55 is a common anode SP4T PIN switch that offers high power handling and low insertion loss in a compact surface mount package. Built on a highly thermally conductive Aluminum Nitride (AlN) substrate, this switch is ideal for high performance commercial and military applications where low loss combined with high adjacent port isolation is required. In addition, the thick copper under metal provides superior loss performance as well as higher bias current handling than traditional metallization schemes. High power diodes have been chosen to provide the optimum blend of loss, isolation and harmonic performance.

FEATURES



- ✓ **High Power Series-Shunt PIN Diode Design**
- ✓ **Broadband operation from 0.225 – 2.5 GHz**
- ✓ **Surface Mount 7mm QFN-style Leadless Package**
- ✓ **Rugged Aluminum Nitride Carrier with Thick Copper Traces**

APPLICATIONS

- ✓ **Microwave Radios**
- ✓ **Military Radios**
- ✓ **VSAT**
- ✓ **Telecom Infrastructure**
- ✓ **Test Equipment**

ELECTRICAL CHARACTERISTICS (+25 C)

Parameter	Conditions	Min	Typical	Max	Units
Insertion Loss	0.225 – 1.0 GHz		0.4	0.8	dB
	1.0 – 2.0 GHz		0.8	1.0	dB
	2.0 – 2.5 GHz		1.0	1.6	dB
Isolation	0.225 – 1.0 GHz	40	45		dB
	1.0 – 2.0 GHz	30	35		dB
	2.0 – 2.5 GHz	23	26		dB
VSWR (I/O)	0.225 – 0.5 GHz		1.3:1	1.7:1	
	0.5 – 1.0 GHz		1.5:1	1.8:1	
	1.0 – 2.0 GHz		1.6:1	2.3:1	
Switching Speed			50		nS

TYPICAL PERFORMANCE (+25°C)

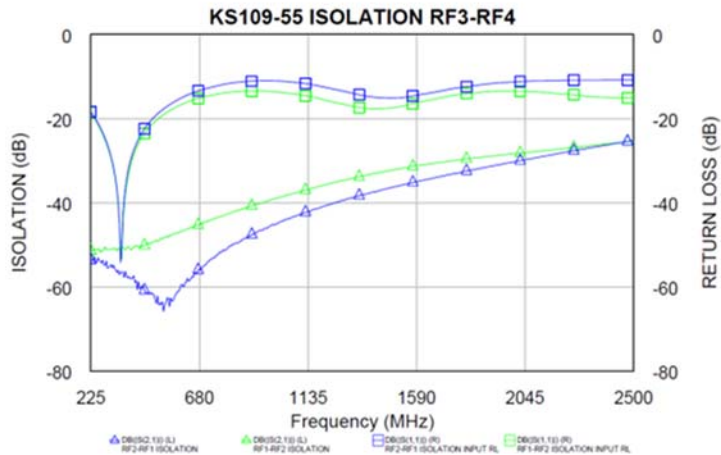
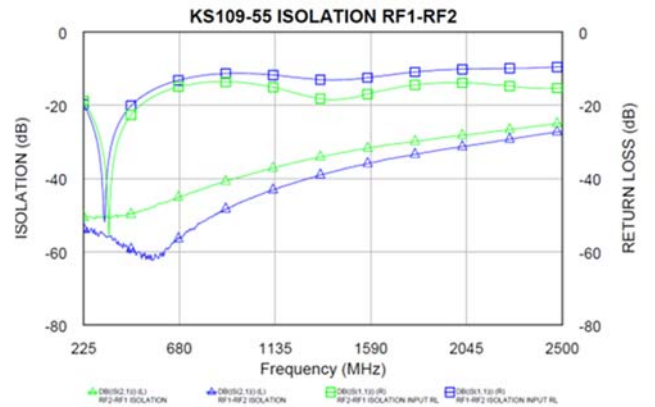
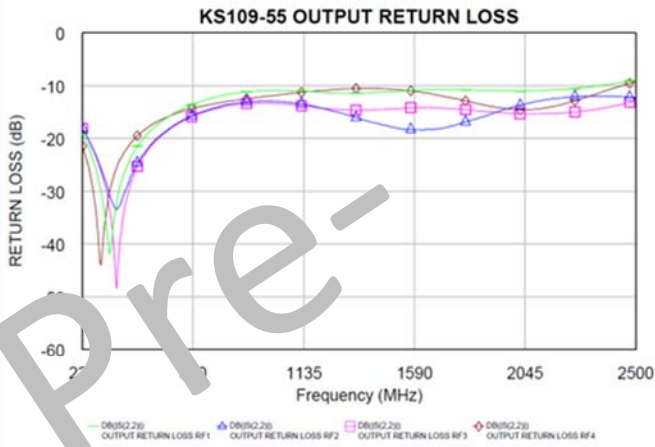
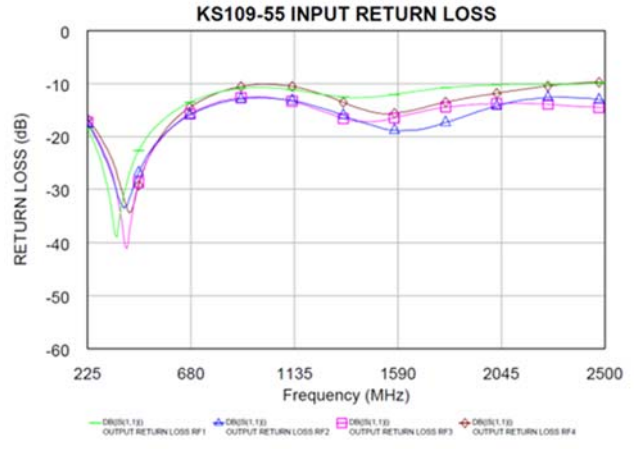
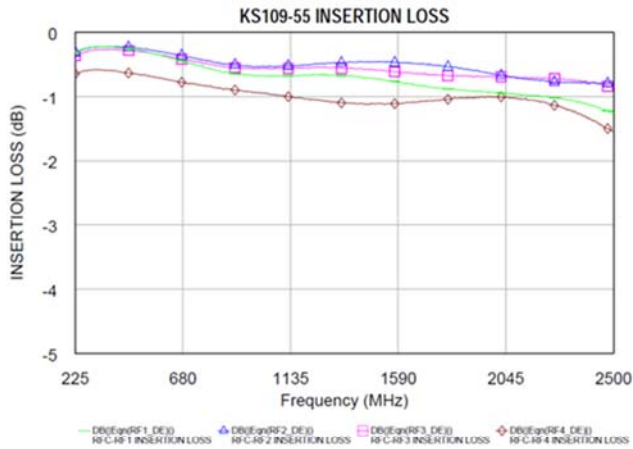

KS109-55 | SP4T 100W SWITCH 0.225–2.5 GHz

TRUTH TABLE/CONTROL CONDITIONS

($V_{RB} = +150V$, $I_{CTL} = 50\text{ mA}$)

CTL1	CTL2	CTL3	CTL4	CTL5	CTL6	CTL7	CTL8	RFC-RF1	RFC-RF2	RFC-RF3	RFC-RF4
$-I_{CTL}$	V_{RB}	V_{RB}	$-I_{CTL}$	$-I_{CTL}$	V_{RB}	$-I_{CTL}$	V_{RB}	Loss	Isolation	Isolation	Isolation
V_{RB}	$-I_{CTL}$	$-I_{CTL}$	V_{RB}	$-I_{CTL}$	V_{RB}	$-I_{CTL}$	V_{RB}	Isolation	Loss	Isolation	Isolation
V_{RB}	$-I_{CTL}$	V_{RB}	$-I_{CTL}$	V_{RB}	$-I_{CTL}$	$-I_{CTL}$	V_{RB}	Isolation	Isolation	Loss	Isolation
V_{RB}	$-I_{CTL}$	V_{RB}	$-I_{CTL}$	$-I_{CTL}$	V_{RB}	V_{RB}	$-I_{CTL}$	Isolation	Isolation	Isolation	Loss

APPLICATION SCHEMATIC

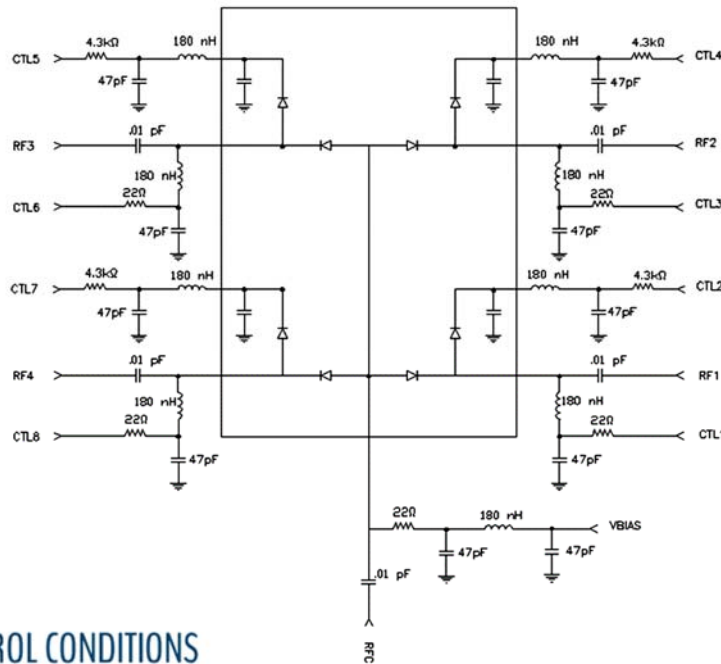

TRUTH TABLE/CONTROL CONDITIONS

($V_{RB} = +150V$, $I_{CTL} = 50\text{ mA}$)



Electrostatic Sensitive Device. Proper ESD precaution should be used when handling device.

CTL1	CTL2	CTL3	CTL4	CTL5	CTL6	CTL7	CTL8	RFC-RF1	RFC-RF2	RFC-RF3	RFC-RF4
GND	Vrb	Vrb	GND	GND	Vrb	GND	Vrb	Loss	Isolation	Isolation	Isolation
Vrb	GND	GND	Vrb	GND	Vrb	GND	Vrb	Isolation	Loss	Isolation	Isolation
Vrb	GND	Vrb	GND	Vrb	GND	GND	Vrb	Isolation	Isolation	Loss	Isolation
Vrb	GND	Vrb	GND	GND	Vrb	Vrb	GND	Isolation	Isolation	Isolation	Loss

SCHEMATIC NOTES:

1. CTL1-CTL8 should be chosen to maintain reverse bias through peak RF voltage excursions during the OFF state and to maintain proper forward bias current (I_{CTL}) during ON state. See truth table.
2. DC blocking capacitors on RF lines should be large enough to provide low loss at the lowest operating frequency.
3. All inductors should be large enough to provide high impedances at the lowest operating frequency.
4. Bypass capacitors should be large enough to adequately filter supply noise from DC control lines.



KS109-55 | SP4T 100W SWITCH 0.225–2.5 GHz

ABSOLUTE MAXIMUM RATINGS

Characteristic	Min.	Max.	Units
Control Voltage (VCTL)	0	250	Volts
RF Input Power		50	W ⁽¹⁾
Storage Temperature	-65	+150	°C
Operating Temperature	-55	+85	°C
Control Current		100	mA
Operating Frequency	0.225	2.5	GHz

Notes:

1. Max Base Plate Temp =+85°C. For temperatures above +85°C derate linearly to +150°C using $P_{max} = 115.38 - 0.769 \cdot T_{amb}$

PINOUT

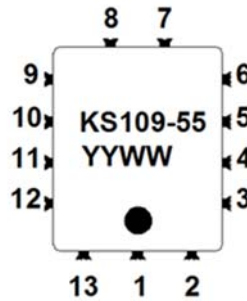

1	RFC
2	NC
3	RF1/CTL1
4	CTL2
5	NC
6	RF2/CTL3
7	CTL4
8	CTL5
9	RF3/CTL6
10	NC
11	CTL7
12	RF4/CTL8
13	NC

OUTLINE DRAWING

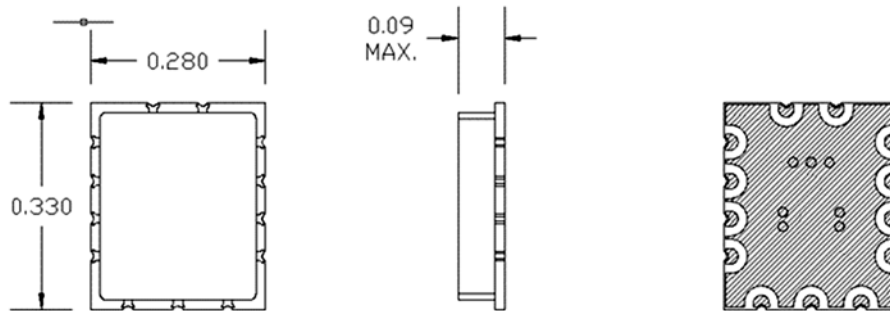

RECOMMENDED SOLDER LAYOUT

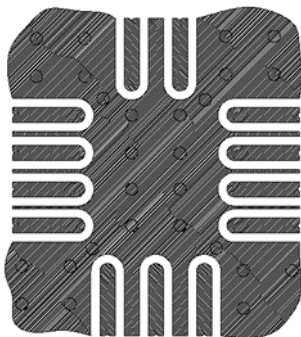

NOTES

1. Use SN-63 solder
2. Flooded ground plane in area outside device leads
3. Add ground vias under part and between corner leads

Contact KCB Solutions for further guidance on device placement and attachment